

SM 6020



SM 6020

SWITCHED MODE LABORATORY POWER SUPPLY

- * 600 Watts DC output
 in 2 ranges, front panel switch selectable

0 - 30 V	0 - 20 A	CV/CC
0 - 60 V	0 - 10 A	CV/CC
0 - 37.5 V / 0 - 75 V optional		
- * Weight only 9 kgs
- * 87% efficiency (40 kHz switching technique)
- * World wide input voltage range
- * Low inrush current
- * Very low output ripple (10mVp-p)
- * Protected against all overload and short circuit conditions
- * Natural convection cooling, no blower, no noise
- * Built-in overvoltage protector, range 6-65 V
- * V and I programmable by voltage (0-5 V)

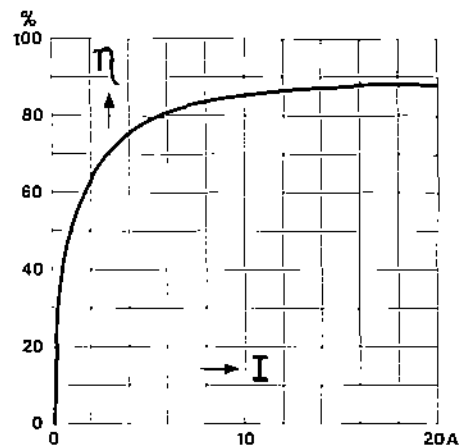
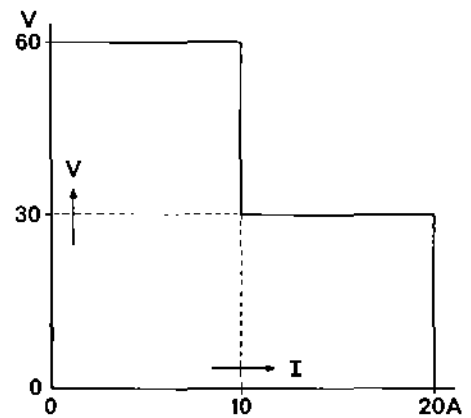

Efficiency versus load current at 30 V output

Ripple voltage

The ripple voltage at the output is less than 10mV peak to peak and there are no high frequency spikes on it due to a carefully designed RFI filter in the output circuit. The photo shows the 40kHz ripple at the output seen on a scope with a bandwidth of 50MHz. Horizontal scale is 20uS/div.

Ripple voltage
10mV/div.

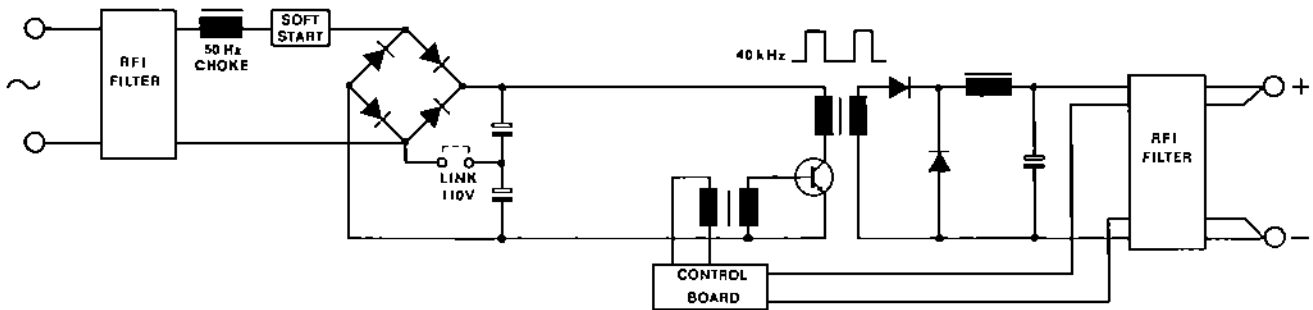
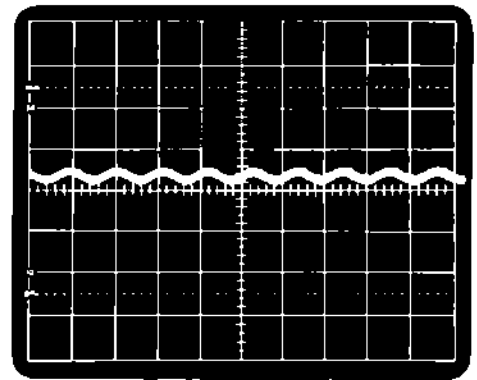

Input voltage

185-265 VAC 50-60Hz or 220-350 VDC or after changing the internal link 95-132 VAC

Input current

At 600 Watts output and 220VAC input the input current is about 4 A rms.

Input choke

A 50Hz choke in the input circuit limits sharp current peaks in order to keep the distortion at the line voltage as low as possible.

Inrush current

During switch on the inrush current is limited by a resistor of 7,5 Ohm which is bridged by a triac during operation. The output voltage comes up about 300ms after switch on.

Line voltage interruption

Photo shows that a line voltage interruption of 80mS (4 cycles) does not affect the output voltage. Load is 60V 5A. At 60V 10A the maximum allowed line voltage interruption is about 30mS.

RFI suppression

Practically no radio frequency interference on input and output due to carefully designed filters.

RFI suppression is in accordance with VDE0875 grade K, both on input and output.

AC input current
4 A/div.

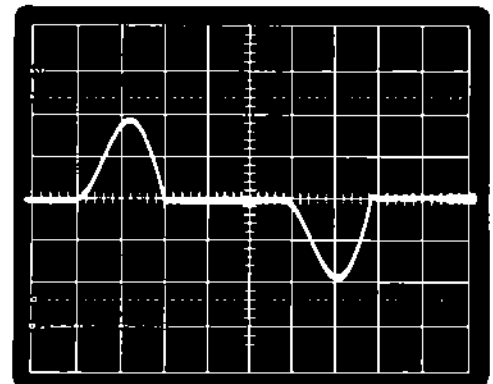

AC input voltage
200V/div.

DC output voltage
50mV/div.

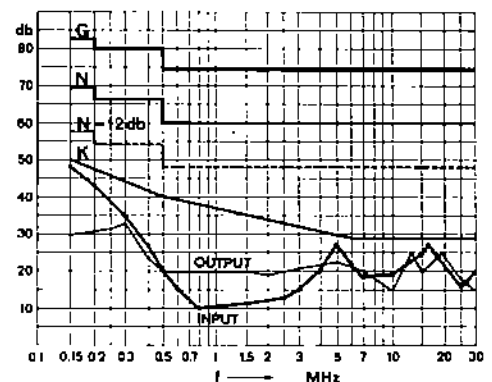
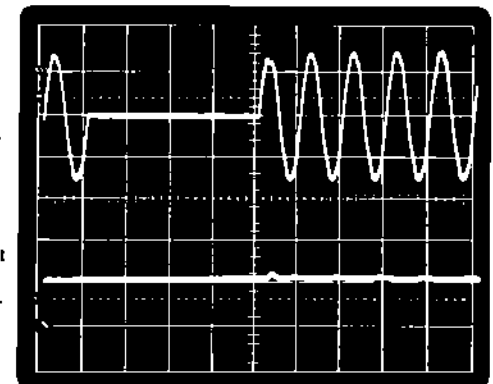

CV/CC regulation

The SM6020 can be used as a constant voltage source with current limiting or as a constant current source with voltage limiting. The change of mode occurs sharply at the crossing of the voltage and current settings.

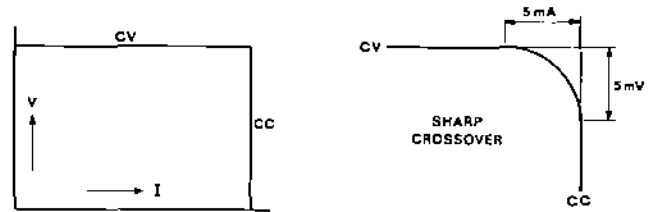

Remote programming

Output voltage and current can be programmed. A programming voltage of 0-5V corresponds with zero to full range of output voltage or current. The maximum programming speed is 600V/sec. However the output electrolytic capacitors might be overheated if a high amplitude is combined with a high repetition frequency. Voltage and current can also be set by external 5kOhm potentiometers.

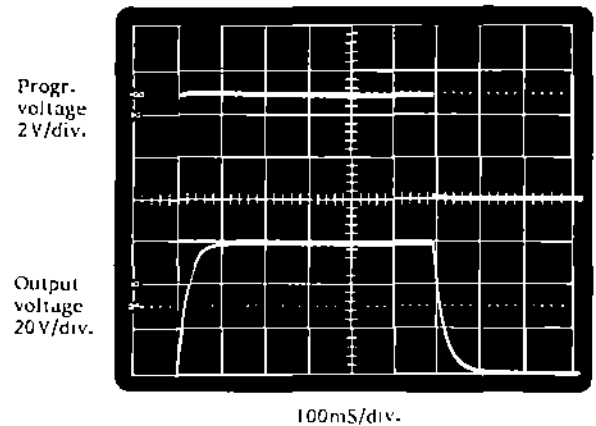

Remote sensing

Normally the sense switch at the rear is at "internal". To keep the voltage constant at the load terminals instead at the output terminals the sense switch has to be put at "external" and sense wires have to be connected from S+ and S- to the load. A maximum of 2V per lead can be compensated.

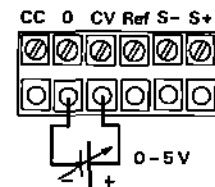

Voltage and current controls

Voltage and current controls are by 10-turn potentiometers for reliable high resolution.

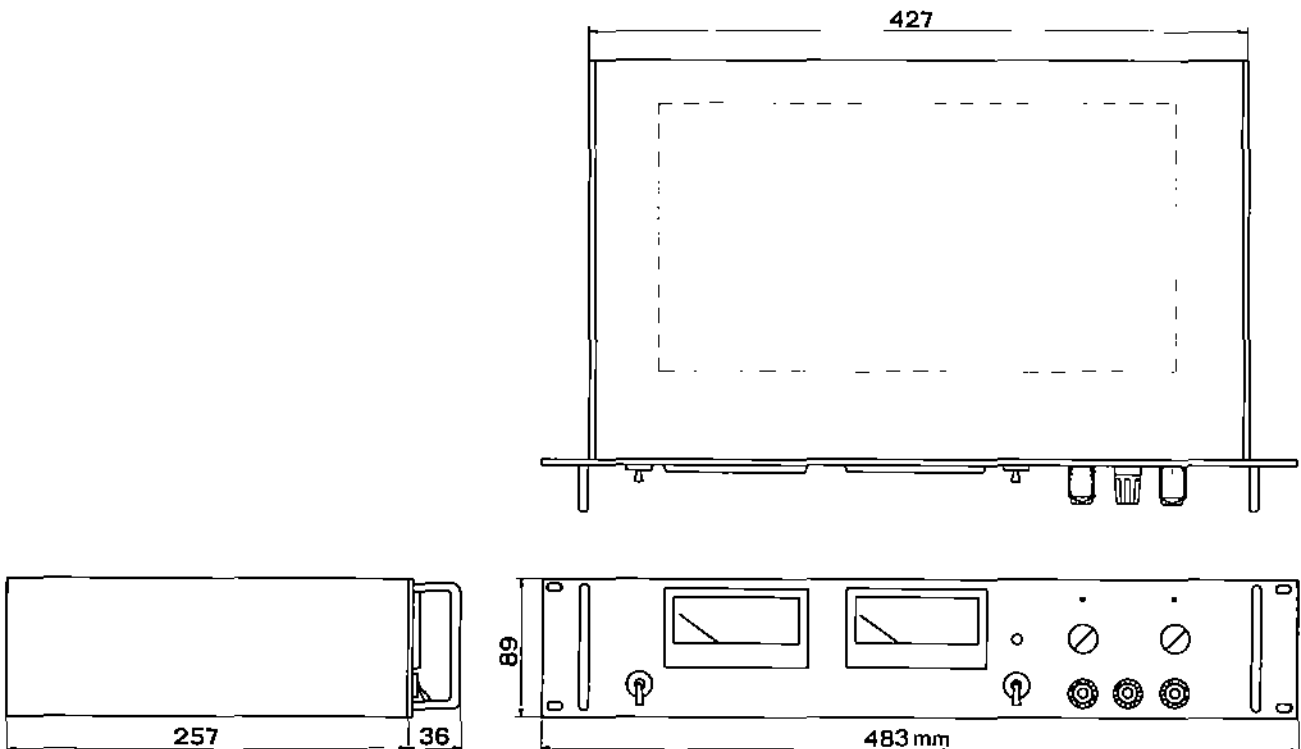

		CV	CC
Line regulation	Input 185-265 VAC	5 mV	70 mA
Load regulation	Load 0-100%	5 mV	70 mA
Ripple + noise p-p		10 mV	50 mA
Temperature coefficient per °C		$5 \cdot 10^{-5}$	$5 \cdot 10^{-4}$

Stability

During 8 hours, after one hour warm up, under constant load and ambient conditions

	$3 \cdot 10^{-4}$	$1 \cdot 10^{-3}$
--	-------------------	-------------------

Output impedance

Up to 100 kHz, less than

	0,1 Ohm	-
--	---------	---

Recovery time

0,5 mS for recovery to within 0,1 V after a load step of 10-100%, measured at 30V 20A.

Efficiency

87%. Total losses are only 90Watts at 600Watts output.

Ambient temperature

-20 to +50°C at full load. At -20°C the recovery time increases to about 1 mS and the ripple to 30mVp-p.

Thermal protection

In case of insufficient cooling a thermoswitch shuts down the output voltage.

Overvoltage protection

Built-in overvoltage protection is adjustable from 6 to 65V with a screwdriver through a hole in the front panel. When the output reaches the setted trip level of the OVP the power supply shuts down. To reset the output it is necessary to switch off the power supply and switch it on again. The OVP is not of the crowbar type and therefore cannot absorb power from external sources. An external voltage exceeding 75V can damage the OVP circuit and the output capacitors.

Parallel and series operation Up to 500V combined output.

Insulation

2,5kVACrms (1 min.) between input and case and between input and output. 500VDC between output and case. Insulation resistance is better than 50MOhm (measured at 500VDC). Safety is in accordance with IEC 348.

Option 75 V

The SM6020 is also available with extended output voltage ranges 0-37,5V/0-75V instead 0-30V/0-60V. At 75V this unit can still supply the full 10A (750W) but at a derated maximum ambient temperature of 35°C instead 50°C. Another limitation is the minimum required AC input voltage which is:

210VAC at 75V 10A (37,5V 20A)
198VAC at 75V 8A (37,5V 16A)
185VAC at 65V 10A (32,5V 20A)

SM 6020

1. INPUT

1.1 185-265VAC 50-60Hz

The SM6020 is normally delivered for input 185-265VAC 50-60Hz to operate on European line voltages 220V and 240VAC.

In this mode the black wire with faston receptacle from the centre tap of the 50Hz choke (L3) is connected to the faston tab at the bottom side of the PC-board P247.

Input fuse: 10A slow blow 6 x 32 mm.

1.2 220-350VDC

In the same configuration as above the SM6020 can also work on 220-350VDC. The polarity does not matter, because the input circuit has a bridge rectifier.

1.3 95-132VAC 50-60Hz

For use on 95-132VAC 50-60Hz, the black wire with faston receptacle from the centre tap of the 50Hz choke (L3) has to be connected to the faston tab on the upper side of P247. In this mode the input circuit acts as a voltage doubler.

Input fuse: 15A slow blow 6 x 32 mm.

1.4 Input current

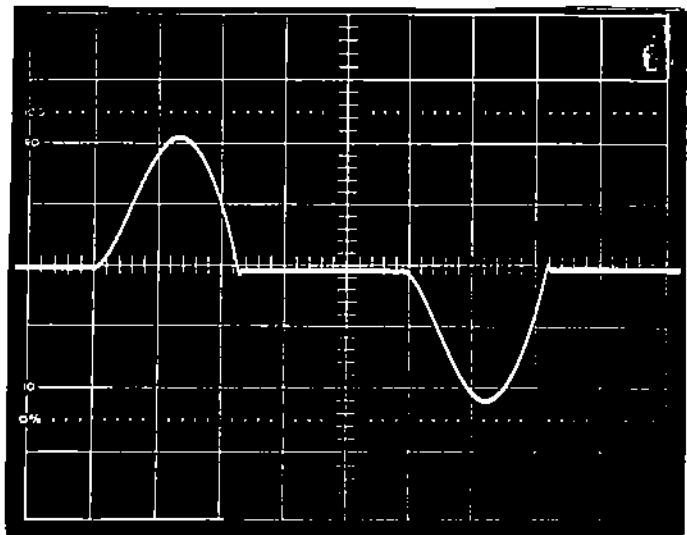

AC input current wave-form
(at 600W load)

Horizontal: 2 mS/div.
Vertical : 4 A/div.

The AC-input current waveform is greatly improved by the low frequency choke in series with the input (This improvement usually lacks in designs of other manufacturers).

Additionally a soft start circuit keeps the peak input current low during switch-on. This circuit consists of a power resistor which is shunted by a triac as soon as the input capacitors are charged.

At 220VAC and full load the input current is about 4A RMS.

1.5 DERATING OF OUTPUT AT INPUT LOWER THAN 185VAC

The SM6020 still functions normal at very low AC input voltages, but with reduced output voltage and current.

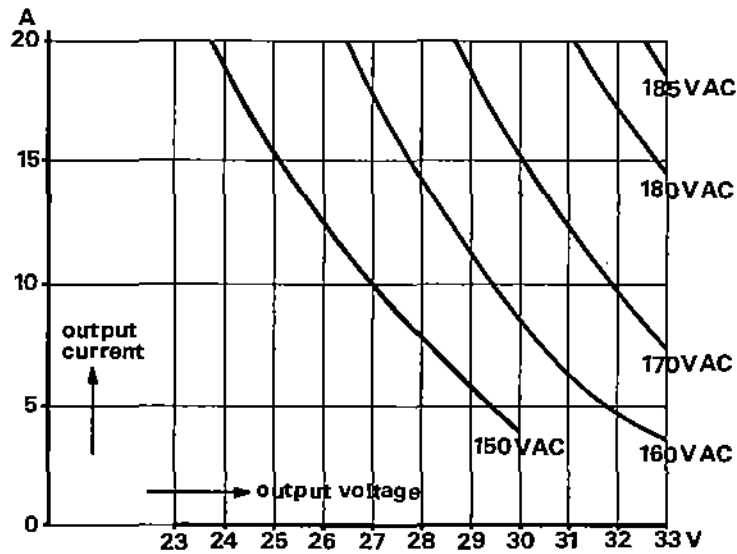

Maximum output current as function of output voltage with AC-line input as a parameter.

1.6 SM6020 USED AS A DC-DC CONVERTER

The SM6020 can also be used as a DC-DC converter at 220VDC input.

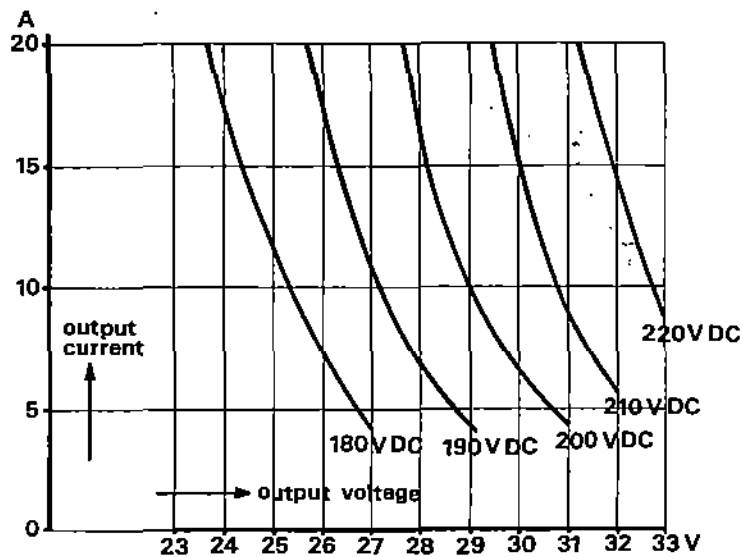

Maximum output current as a function of output voltage with DC-line input as a parameter.

2. INTERNAL OR EXTERNAL SENSING

In most applications the power supply is used with internal sensing, which means that the output voltage is kept constant at the output terminals on the front panel. In this case the sense switch, accessible through a hole of the rear panel, has to be in the position "Internal".

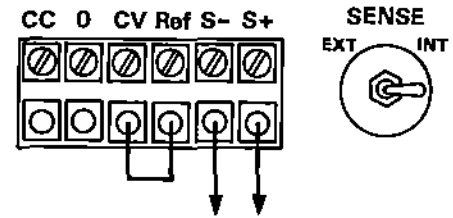

If it is desirable to compensate the voltage drop over the leads to the load, the points of stabilisation can be displaced from the output terminals to the load terminals by using sense wires from S+ and S- (rear terminal block) to the load and putting the sense switch in the position "External".

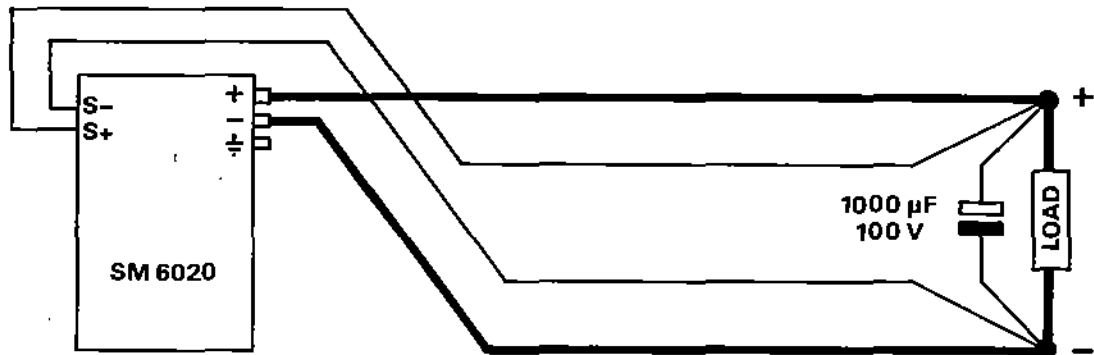

To prevent for undesirable interference or oscillation it is advisable to twist the sense leads and to connect an electrolytic capacitor to the load terminals.

3. OVER VOLTAGE PROTECTOR

The built-in over voltage protector can be adjusted between 6V and 65V with a screwdriver through the front panel.

When the output reaches the setted trip level of the OVP the power supply shuts down. To reset the output voltage it is necessary to switch off the power supply and switch on again.

The OVP is not of the crowbar type and therefore cannot absorb power from external sources. An external voltage exceeding 100V can damage the internal OVP circuit and the output capacitors.

4. VOLTAGE AND CURRENT CONTROL BY FRONT PANEL POTENTIOMETERS

Connect a link between CV and Ref at the rear terminal block. Take care that the sense-switch is on INTERNAL.

The internal current prog switch S4 on P266 has to be in the position "Front panel current control"(As on delivery of the SM6020).

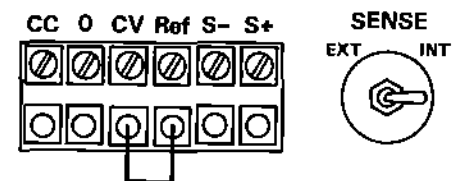

Voltage and current controls are by 10-turn potentiometers for reliable high resolution.

10 turns of the voltage control corresponds with 0 to 60V.

10 turns of the current control corresponds with 0-20A.

When the output range selector switch is at 0-30V 20A, only the first 5 turns of the voltage control knob react. This means that the output voltage will not rise to the double value when the selector switch is switched to 60V by error. The same happens with the current control knob when the selector switch is at 60V 10A.

5. REMOTE PROGRAMMING

5.1 VOLTAGE BY VOLTAGE

To program the output voltage by an external voltage, connect the driving voltage between CV and 0 at the rear terminal block.

A driving voltage of 0 to about 5V programs the output from 0 to 60V.

Terminal 0 is internally connected to S- of the output and an internal fuse in series is protecting the sense wire for burn out in case of a wrong connection.

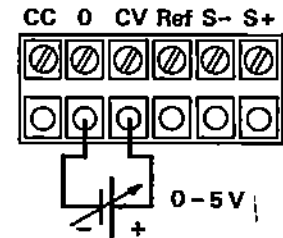

5.2 VOLTAGE BY EXTERNAL POTENTIOMETER

To set the output voltage with an external potentiometer, connect a potentiometer of 5 kOhm to the terminals Ref, CV and 0 and turn the potentiometer at the front panel on maximum.

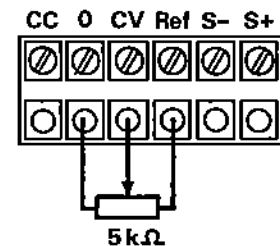

5.3 VOLTAGE BY CURRENT

For max. output voltage applies:

$$R = \frac{5}{I_{\text{prog}}}$$

For example: With $R = 500 \text{ Ohm}$ a current of 0-10mA will program the output 0-60V

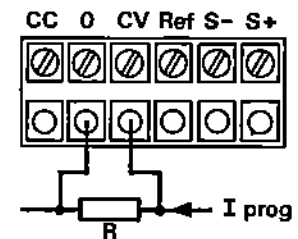

5.4 CURRENT BY VOLTAGE

To make this possible the internal switch S4 on P266 has to be put in the position "current prog".

With about 0-5V between the terminals CC and 0 the output current varies between 0 and 20A if working in the current mode.

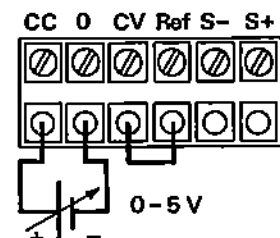
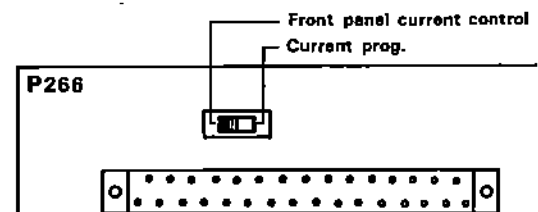

5.5 CURRENT BY EXTERNAL POTENTIOMETER

Internal switch S4 on P266 at "current prog". If no external 5V source is available the CV reference has to be used to power the external current control potentiometer. This is possible if the voltage control potentiometer at the front panel is turned on maximum.

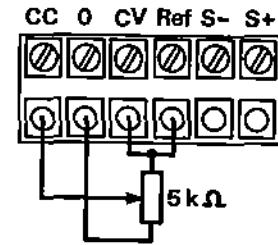

5.6 CURRENT BY CURRENT

Internal switch S4 on P266 at "current prog". For maximum output current applies:

$$R = \frac{5}{I_{\text{prog}}}$$

For example with $R = 500 \text{ Ohm}$ a current of 0-10 mA can program the output 0-20A.

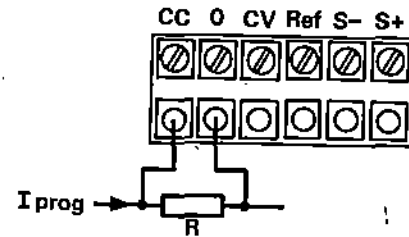

6. PROGRAMMING SPEED

The programming speed is very much limited by the electrolytic capacitors on the output, which will heat up at a combined high repetition rate, high amplitude and high programming speed. The maximum programming speed is about 600V/sec., however the product of dv/dt (in V/s) x amplitude (in V) x repetition frequency (in Hz) may not exceed $2 \cdot 10^4$.

Upper diagram:
Programming voltage.
Vertical scale 2V/div.

Lower diagram:
Output voltage.
Vertical scale 20V/div.

Horizontal scale 100mS/div.

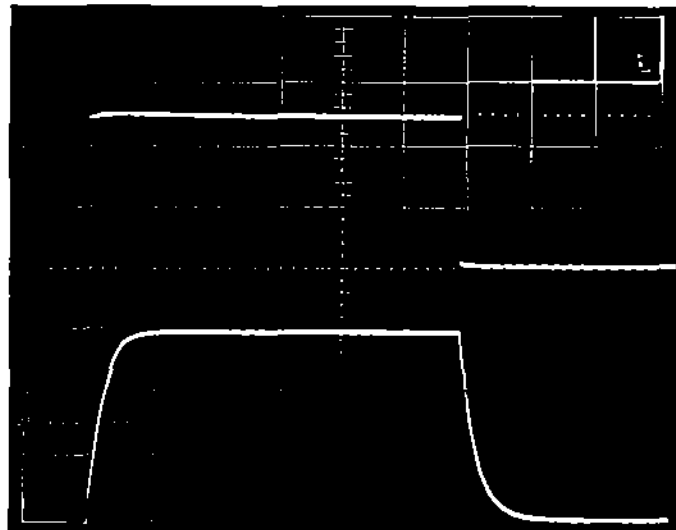

7. OUTPUT ON/OFF BY AN EXTERNAL CONTACT

The output can be switched on and off by shorting terminal CV to terminal 0 by a switch or a reed relays contact. Instead of a link a resistor of 1kOhm has to be connected between Ref and CV.

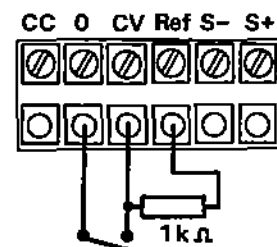

8. PARALLEL OPERATION

8.1 PARALLEL OPERATION IN CV MODE

Several units SM6020 can be connected in parallel to obtain a higher current. Before putting in parallel first adjust all outputs to the same voltage. Use leads of equal length from each output to the summing point. When the outputs are unequal the power supply with the highest output starts to supply all the current till it goes in constant current. Then the output drops to the next highest setted voltage etc.

No provision is made for master and slave parallel operation.

8.2 PARALLEL OPERATION IN CC MODE

In the CC mode the total current is the sum of the setted individual currents.

9. SERIES OPERATION

9.1 SERIES OPERATION IN CV MODE

Power supplies SM6020 may be connected in series to a maximum total voltage of 500V (max. 8 units), by simply connecting the plus of the one with the minus of the next. The voltage control potentiometers can be set individually at different values, but the CC potentiometers have to be set at an about equal maximum current which is safe for the load.

9.2 MASTER AND SLAVE SERIES OPERATION IN CV AND CC MODE

If it is required to control the voltage or current of the series connection by controlling one unit (the master), some extra circuitry is necessary.

With this circuit the total voltage can continuously be varied from zero to full by the voltage control potentiometer of the master, or by programming the master as described under 6.1 to 6.3.

Also the current of the series connection is only determined by the current setting or programming of the master. The current control knobs of the slaves have to be put on maximum in this case. A disadvantage of this circuit is that the programming speed is much lower than with one unit.

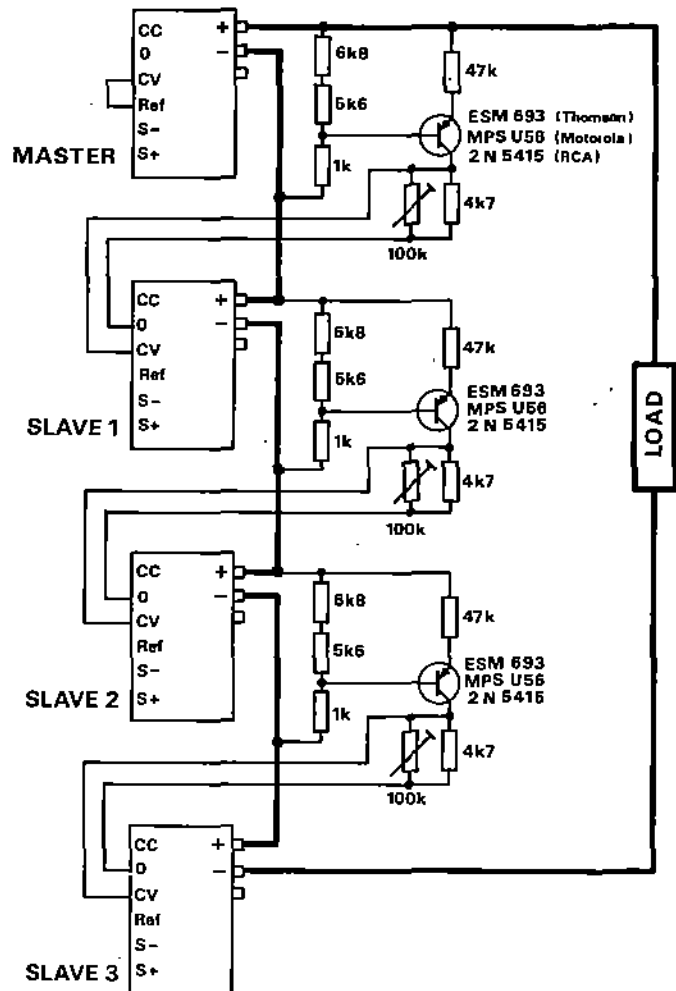

MASTER AND SLAVE SERIES CONNECTION

9.3 SERIES OPERATION IN CC MODE

If in the CC mode the output voltage of one unit is not sufficient a second unit (in CV mode) can be put in series. The current setting of the first unit will then still determine the constant current as long as the voltage variation caused by the load is less than the max. voltage of one unit (60V).

When the voltage variation exceeds the max. voltage of the first unit, the constant current will in one step change to the setted current of the second one. To keep this step change small the CC setting of both units can be put at the same value before connecting in series.

The additional circuit of 9.2 overcomes these difficulties.

10. LOAD RIPPLE AND PEAK CURRENTS

Ripple currents caused by the load at frequencies below 1 kHz are compensated by the voltage regulation.

However high load ripple currents which exceed the current limit or which have strong components above 1 kHz can overheat the output electrolytic capacitors. Also repetitive high peak currents, like taken by thyristor DC-AC inverters can have this effect. In such a case an electrolytic capacitor of 10.000 μF parallel to the load is recommended.

11. OUTPUT IMPEDANCE

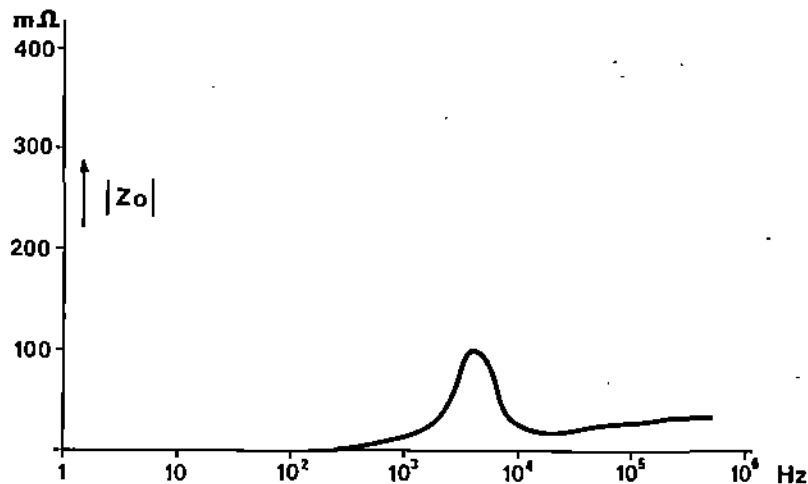

Output impedance as function of load frequency

12. THERMAL PROTECTION

A thermal shut down circuit protects the power supply against overheating in case of insufficient cooling.

13. SM6020 USED AS A BATTERY CHARGER

CV/CC regulated power supplies are ideal battery chargers. However sometimes the internal wiring is burned out by connecting the polarity of the battery wrong by error.

The SM6020 has a heavy diode in reverse polarity parallel to the output terminals, directly behind the front panel. However this diode cannot withstand the hundreds of amperes supplied by a wrong connected battery. So it is recommended to use always a fuse in series with the battery.

14. SUPPRESSION OF HIGH ENERGY, HIGH VOLTAGE INTERFERENCE

14.1 SYMMETRICAL HV INTERFERENCE (LINE TO LINE)

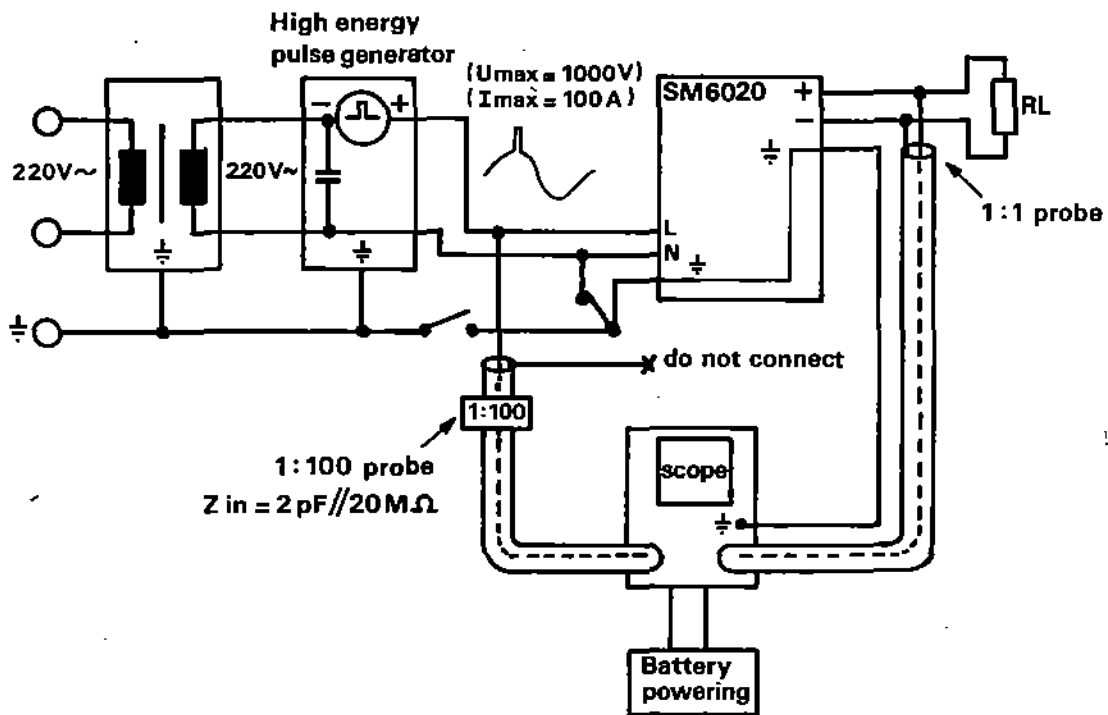

Input voltage (line to line)
500V/division
Probe 1:100 with
 $Z_{input} = 2 pF // 20 M\Omega$

DC output voltage
10mV/division
Probe 1:1

Horizontal scale 5mS/div.

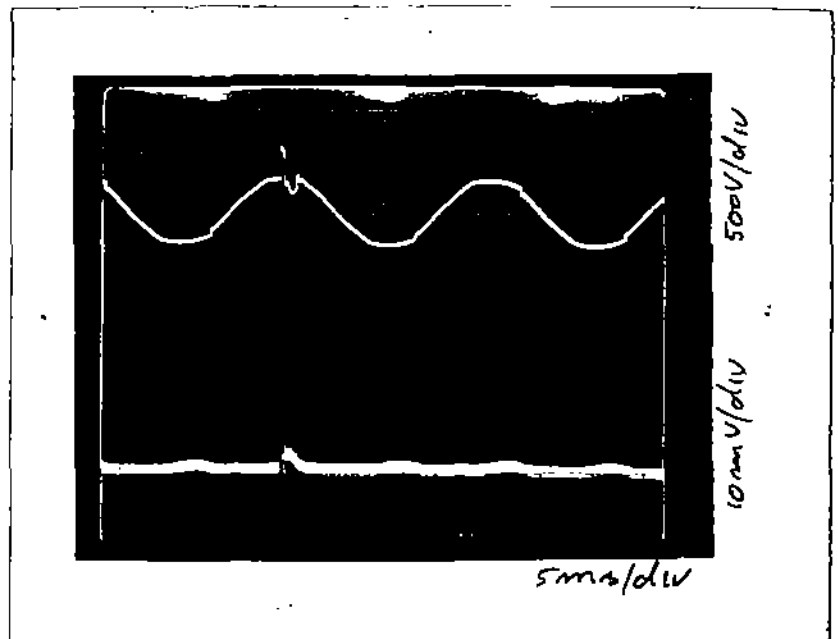

The input of the SM6020 is protected against short duration, high voltage pulses by means of a varistor, which clips these pulses at about 700V peak.

At above scope photo is shown how a 1000V, 300 μ S pulse on the AC input is clipped at about 700V above zero level by the varistor.

The lower diagram shows that this high energy pulse causes only a very small spike of about 20mV peak to peak at the regulated DC output voltage, which is almost negligible.

14.2 ASYMMETRICAL HV INTERFERENCE (LINE TO EARTH)

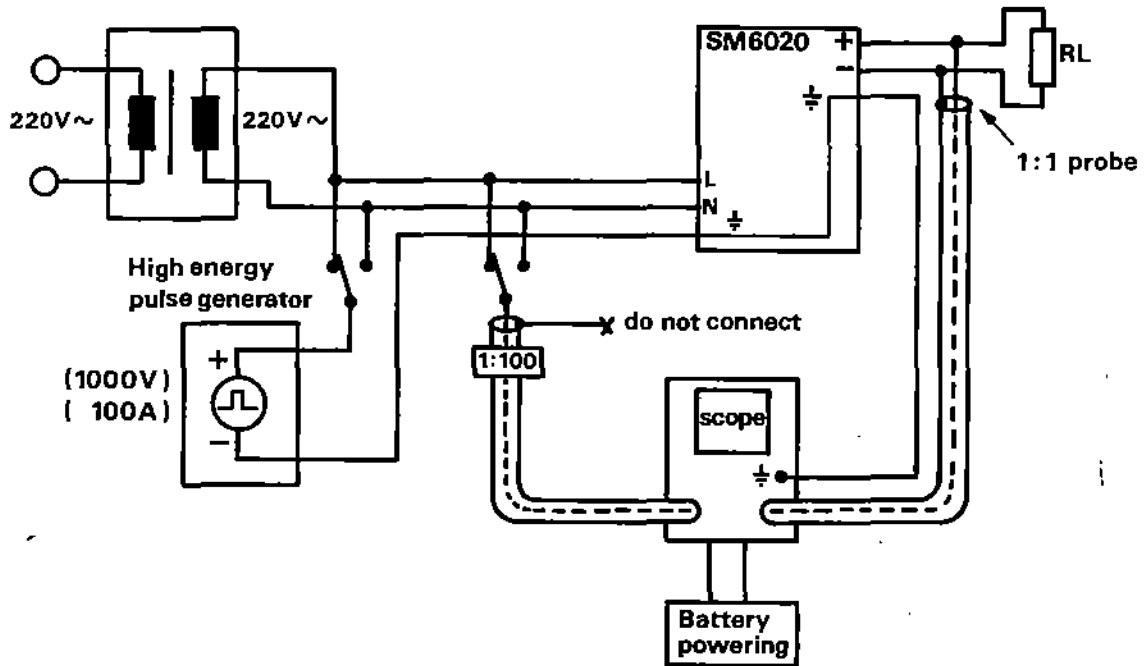

Voltage between input
and case, 500V/division
Probe: 1:100 with
 $Z_{\text{input}} = 2\text{pF} // 20\text{M}\Omega$

DC output voltage
100mV/division
Probe 1:1

Horizontal scale 5mS/div.

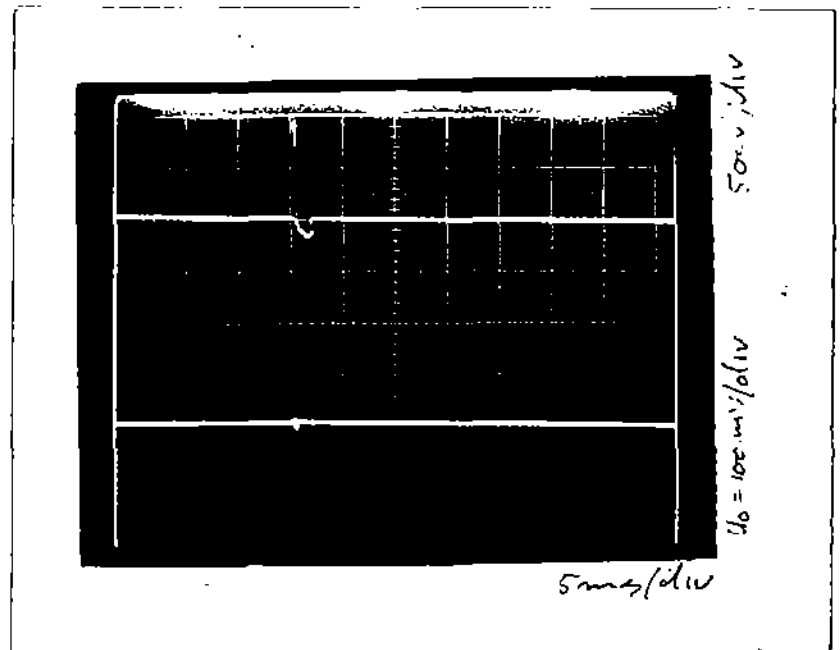

Above scope photo shows that a 1000 V, 200 μs pulse between line and earth causes only a 20mV peak to peak disturbance on the regulated DC output voltage.

15. OPTION "0-75V"

The SM6020 is also available with option "0-75V", which means extended output voltage ranges 0-37,5V/0-75V instead of 0-30V/0-60V.

At 75V this unit can still supply the full 10A (750W) but at a derated maximum ambient temperature of 35°C instead of 50°C.

Another limitation is the lowest AC input voltage, which is:

210VAC (250VDC) at 75V 10A (37,5V 20A)
 198VAC (235VDC) at 75V 8A (37,5V 16A)
 185VAC (220VDC) at 65V 10A (32,5V 20A)

When connected for 110VAC these values are 108V, 102V and 95V respectively.

All other specifications are unchanged.

16. TROUBLE SHOOTING

No output: In case of no output after switch on first check:

- * If link between CV and Ref (on rear panel) is made.
- * If sense switch is on "internal".
- * If CV and CC control potentiometers are not on zero.
- * If perhaps the OVP has tripped (Turn up OVP potmeter and switch unit off and on again).
- * If perhaps the internal switch S4 on P266 is at "Front panel current control" (see 5.4, page 6).

Warning:

Before opening the cover first disconnect the line cord and wait a few minutes till all capacitors are discharged.

Internal fuse:

When the internal fuse F3 is found blown, do not replace it, because it means that the power switching transistor Q1 on P262 is defective. Replacing fuse F3 in such a case will cause wire wound resistor R3 on P268 to burn out.

Fault finding

Check diodes D51,52,53,54 of output circuit with an Ohmmeter. If defective Q1 at P262 will also be defective. Replace defective diodes and exchange P262

Modular construction:

The SM6020 is built up modular and all modules are fully exchangeable. It is recommended not to try to repair modules but to send them to Delta for repair and inspection.

Repair of P262

Disconnect all terminals of P262. Disconnect Q1 (BUV98). Check diodes D3,4,9 with Ohmmeter. D5 has to be disconnected to check. Replace defective parts.

When repairing old models leave D3 out and replace D4 (BY218-800) by BYT12P800 (Sescosem) and D5 (BY218-800) by BYV96D (Philips).

Check R3 on P268 and replace defective fuse F3 (8A type F).

R = Ohm			
1 = Z 21 L 471	63 = 1 k	100 = 22	
2 = 2,2 M VR 25	64 = 56 k	101 = 22	
3 = 15 10 W WW	65 = 4,7 k	102 = 22	
4 = 120 PR 37	66 = 3,9 k	103 = 22	
5 = 47 7 W WW	67 = 2,2 M VR 25	104 = 1	
6 = 47 7 W WW	68 = 10 k	105 = 1 k trim	
7 = 100 k MK 3	69 = 22 k	106 = 180	
8 = 100 k MK 3	70 = 22 k	107 = 56 k	
9 = 1 7 W WW	71 = 3,3 k	108 = 10 k trim	
10 = 10 PR 37	72 = CR	109 = 2,2 M VR 25	
11 = 100 25 W RCL	73 = 12 k	110 = 10 k	
12 = 470	74 = 2,7 k	111 = 10 k	
13 = 68 k	75 = 39 k	112 = 10 k	
14 = CR	76 = 56 k MK 3	113 = 10 k	
15 = 68 k	77 = 56 k MK 3	114 = 2,2 k	
16 = 1,2 k	78 = 4,7 k	115 = 3,3 k	
17 = 390 k	79 = 680	116 = Z 7 L 821	
18 = CR	80 = 2,7 k	117 = 22 k	
19 = 390 k	81 = 5 k 10 trns	118 = 15 10W WW	
20 = 100 k MK 3	82 = -		
21 = 100 k MK 3	83 = 560		
22 = 100 k MK 3	84 = 4,7 k		
23 = 100 k MK 3	85 = 1 k		
24 = 270	86 = 10 k 10 trns		
25 = 330	87 = 680		
26 = 100	88 = 470		
27 = 1 k	89 = 270		
28 = 10 k	90 = 330 PR 37		
29 = 33 k	91 = 27 PR 37		
30 = CR	92 = 27 PR 37		
31 = CR	93 = 2,2 7 W		
32 = 6,8	94 = 1,2 k 10 W		
33 = CR	95 = 120		
34 = -	96 = 3,3 k		
35 = 15	97 = 0,01 1% 50 W		
36 = 1 k	98 = 22		
37 = 330	99 = 22		
38 = 6,8 k			
39 = 100			
40 = 2,2 k			
41 = 1 k			
42 = 470			
43 = 470			
44 = 1 k			
45 = 150			
46 = -			
47 = 2,2 k			
48 = 1,8 k			
49 = 2,2 k			
50 = 68 k MK 3	CR = calibration resistor		
51 = 2,2 k	WW = wire wound		
52 = 2,7 k	MRS 25 = metal film 0,4 W 1%		
53 = 2,7 k	MK 3 = metal film 0,5 W 1%		
54 = 2,2 k	PR 37 = metal film 1,6 W 5%		
55 = 2,7 k	VR 25 = metal film 0,25W 5% 1600 V-		
56 = 2,7 k			
57 = 150 k	All non specified resistors are of		
58 = 820 k	type MRS 25		
59 = 5 k 10 trns			
60 = 33 k			
61 = CR			
62 = 1 k			

			Title: Part list SM6020
R ₄₂ = 470Ω	7-'86	Vr.	Date: 1-'79
Modifications	Date	App.	delta elektronika bv



C			
1 =	0,22	μ F	250 V~
2 =	2,2	nF	4 kV
3 =	0,22	μ F	250 V~
4 =	0,22	μ F	250 V~
5 =	2,2	nF	4 kV
6 =	1,5	μ F	160 V
7 =	0,15	μ F	250 V~
8 =	800	μ F	200 V
9 =	800	μ F	200 V
10 =	800	μ F	200 V
11 =	800	μ F	200 V
12 =	800	μ F	200 V
13 =	800	μ F	200 V
14 =	1	μ F	400 V
15 =	3,3	μ F	100 V
16 =	10	μ F	63 V
17 =	10	nF	1000 V
18 =	1,8	nF	2 kV
19 =	1,8	nF	2 kV
20 =	1,8	nF	2 kV
21 =	10	pF	4 kV
22 =	100	μ F	10 V
23 =	15	pF	500 V
24 =	150	pF	400 V
25 =	470	pF	160 V
26 =	47	pF	500 V
27 =	100	pF	500 V
28 =	0,1	μ F	400 V
29 =	150	pF	1600 V
30 =	0,22	μ F	63 V
31 =	15	μ F	16 V
32 =	15	μ F	16 V
33 =	1	nF	630 V
34 =	22	μ F	40 V
35 =	15	μ F	16 V
36 =	470	pF	160 V
37 =	-		
38 =	10	nF	250 V
39 =	220	nF	63 V
40 =	47	nF	250 V
41 =	470	pF	160 V
42 =	100	pF	500 V
43 =	15	μ F	16 V
44 =	470	pF	160 V
45 =	470	pF	160 V
46 =	47	μ F	40 V
47 =	15	μ F	16 V
48 =	1	nF	630 V
49 =	1	nF	630 V
50 =	15	μ F	16 V
51 =	15	μ F	16 V
52 =	470	pF	500 V
53 =	470	pF	500 V
54 =	10	nF	1000 V
55 =	1	nF	630 V
56 =	100	pF	500 V
57 =	470	pF	500 V
58 =	10	nF	250 V
59 =	470	pF	500 V
60 =	15	μ F	16 V
61 =	15	μ F	16 V
62 =	470	pF	500 V
63 =	22	nF	250 V
64 =	47	nF	250 V
65 =	470	pF	500 V
66 =	15	μ F	16 V
67 =	15	μ F	16 V
68 =	2,5	nF	250 V~
69 =	2,5	nF	250 V~
70 =	10	μ F	100 V
71 =	10	μ F	100 V
72 =	470	μ F	100 V
73 =	220	nF	63 V
74 =	470	μ F	100 V
75 =	470	μ F	100 V
76 =	470	μ F	100 V
77 =	470	μ F	100 V
78 =	470	μ F	100 V
79 =	470	μ F	100 V
80 =	47	μ F	63 V
81 =	0,22	μ F	250 V~
82 =	15	μ F	16 V
83 =	0,22	μ F	63 V
84 =	0,22	μ F	63 V
85 =	0,22	μ F	63 V
86 =	0,22	μ F	63 V
87 =	0,22	μ F	63 V
88 =	0,22	μ F	250 V~
89 =	47	μ F	63 V
90 =	15	μ F	16 V
91 =	470	μ F	100 V
92 =	10	nF	1000 V
93 =	470	μ F	100 V
94 =	1	μ F	250 V
95 =	470	nF	250 V
96 =	10	nF	1000 V
97 =	0,15	μ F	250 V~
98 =	5	nF	250 V~

			Title: Part list SM6020	
Serial 0200 and up	11-'81	V	Date: 1-'79	
Modifications	Date	App	delta elektronike bv	

D

1 = T 2513 NK	TAG	41 = 1N825	IR
2 = SKB 25/06	Semicron	42 = 1N4148	
3 = -		43 = 1N4148	
4 = BYT 12 P 800	Sescosem	44 = 1N4148	
5 = BYV 26 D	Philips	45 = 1N4148	
6 = BY 218-800	Sescosem	46 = 1N4148	
7 = -		47 = 1N4148	
8 = BZV 15C 12	Philips	48 = ZPD 5,1	ITT
9 = BY 218-800	Sescosem	49 = ZPD 8,2	ITT
10 = BY 218-800	Sescosem	50 = 1N825	TI
11 = BY 218-800	Sescosem	51 = BYW 77/200	Sescosem
12 = ZPD 8,2	ITT	52 = BYW 77/200	Sescosem
13 = 1N4148		53 = BYW 77/200	Sescosem
14 = ZPD 3,3	ITT	54 = BYW 77/200	Sescosem
15 = 1N4148		55 = 40 HF10/1N249C	IR/RCA
16 = BYV 26 D	Philips	56 = 1N4148	
17 = BYV 26 D	Philips	57 = 40 HF10/1N249C	IR/RCA
18 = BZV 15C 12	Philips	58 = 1N4148	
19 = BYV 26 D	Philips	59 = 1N4148	
20 = ZPD 8,2	ITT	60 = TL 431	TI
21 = ZPY 13	ITT	61 = 40 HF10/1N249C	IR/RCA
22 = 1N4148		62 = ZPD 8,2	ITT
23 = 1N4148		63 = ZPD 10	ITT
24 = 1N4148		64 = 1N4148	
25 = 1N4148			
26 = ZPY 51	ITT		
27 = ZPD 3,3	ITT		
28 = PO 102 BA	TI		
29 = CQY 54-3	Philips		
30 = CQY 54-3	Philips		
31 = 1N4148			
32 = 1N4148			
33 = 1N4148			
34 = 1N4148			
35 = ZPD 8,2	ITT		
36 = 1N4148			
37 = 1N4148			
38 = 1N4148			
39 = 1N4148			
40 = 1N4148			

D3,16,17,19,28	10-'86	Vr.	Title: Part list	
D3,4,5,16,17,19	12-'84	Vr.	SM6020	
Serial 0200 and up	11-'81	Vr.	Date: 1-'79	
Modifications	Date	App.	delta elektronika bv	

<u>Q</u>			<u>F</u>		
1 =	BUV 98 A	Sescosem	1 =	10 A (220V), 15A (110V)	slow blow
2 =	-		2 =	10 A (220V), 15A (110V)	slow blow
3 =	-		3 =	8 A	FAST
4 =	-		4 =	315 mA	FAST
5 =	BUX 84	Philips	5 =	315 mA	FAST
6 =	2 N 2907 A	Sescosem			
7 =	2 N 2222 A	Sescosem			
8 =	BS 250	ITT	<u>L</u>		
9 =	BD 522	ITT	1 =	S 144	Delta
10 =	BD 522	ITT	2 =	S 144	Delta
11 =	BD 522	ITT	3 =	S 133	Delta
12 =	BD 522	ITT	4 =	S 146	Delta
13 =	BD 522	ITT	5 =	4,7 μ H	Secre
14 =	2 N 2907 A	Sescosem	6 =	S 147	Delta
15 =	2 N 2907 A	Sescosem	7 =	S 148	Delta
16 =	2 N 2222 A	Sescosem	8 =	2,2 μ H	Secre
17 =	2 N 2222 A	Sescosem			
18 =	2 N 2907 A	Sescosem			
19 =	2 N 2907 A	Sescosem			
20 =	2 N 2907 A	Sescosem	<u>T</u>		
21 =	2 N 2222 A	Sescosem	1 =	T 149	Delta
<u>IC</u>			2 =	T 150	Delta
1 =	HEF 4049 B	Philips	3 =	AT 4043/47	Philips
2 =	HEF 4069 UB	Philips	4 =	-	
3 =	HEF 4069 UB	Philips	5 =	T 156	Delta
4 =	SFC 2747 M	Sescosem			
5 =	SFC 2747 M	Sescosem			

			Title: Part list SM6020	
Serial 0200 and up	11-81	Vr	Date: 1-'79	
Modifications	Date	App.	delta elektronika bv	

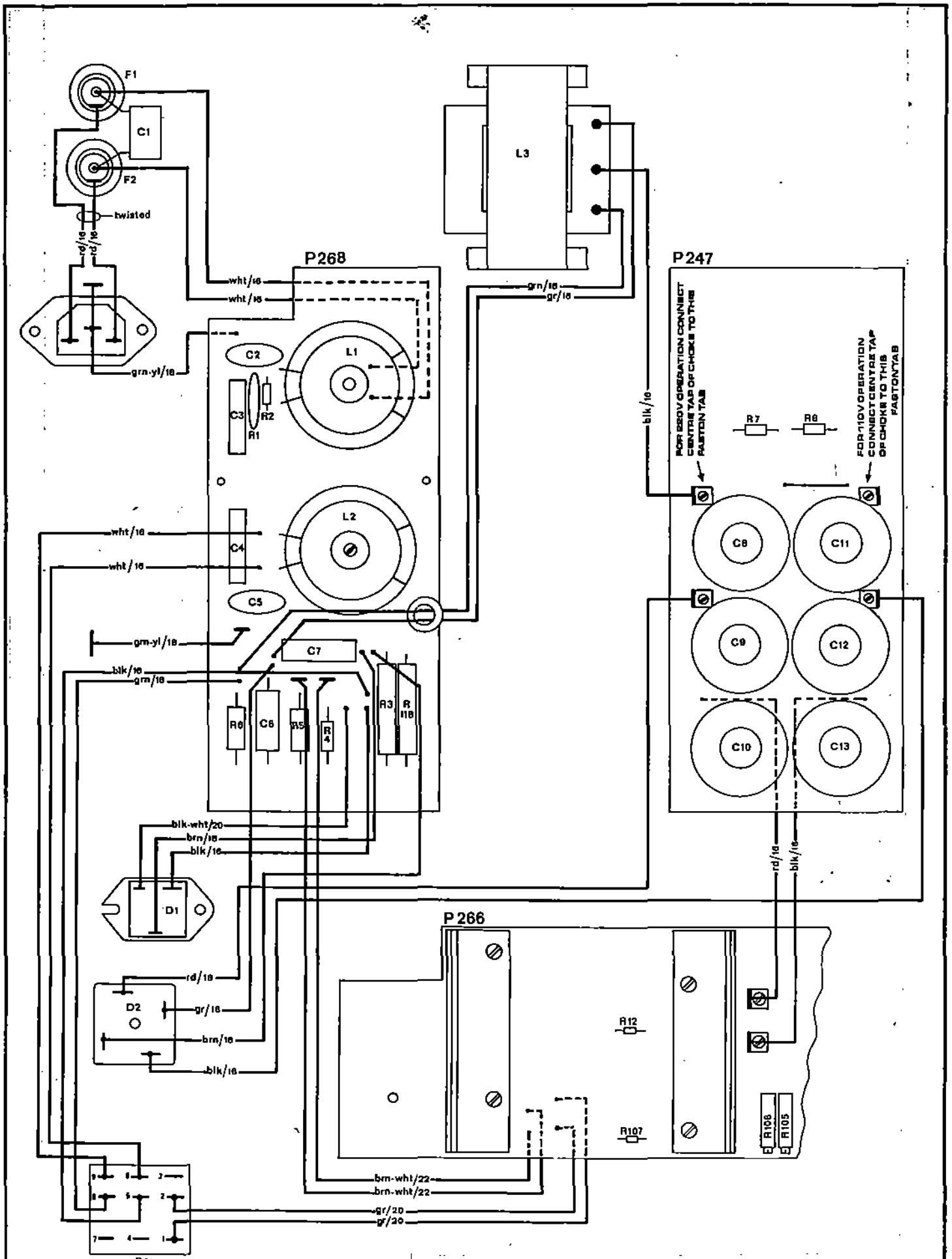

R110 (P268)	12.84	1/2	Title: Wiring diagram SM6020
Serial 0200 and up	11.81	1/2	
Modifications	Date	App.	delta elektronika bv



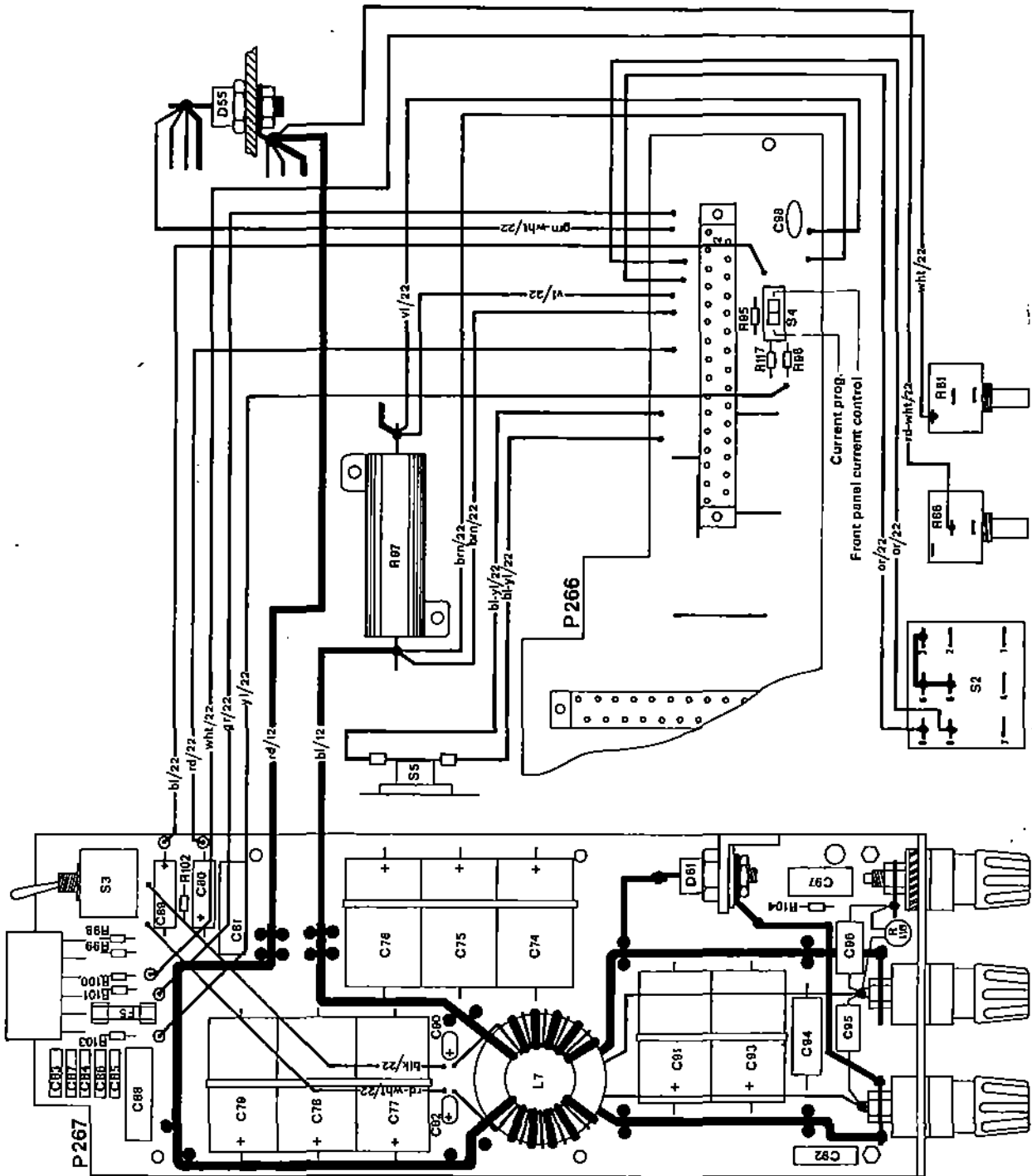

Title: Wiring diagram	
R117	U.
6-83	U.
Serial 0200 and up	U.
Date App	Date
Modifications	App
	by



SM6020
Date: 1-'79
delta elektronika bv

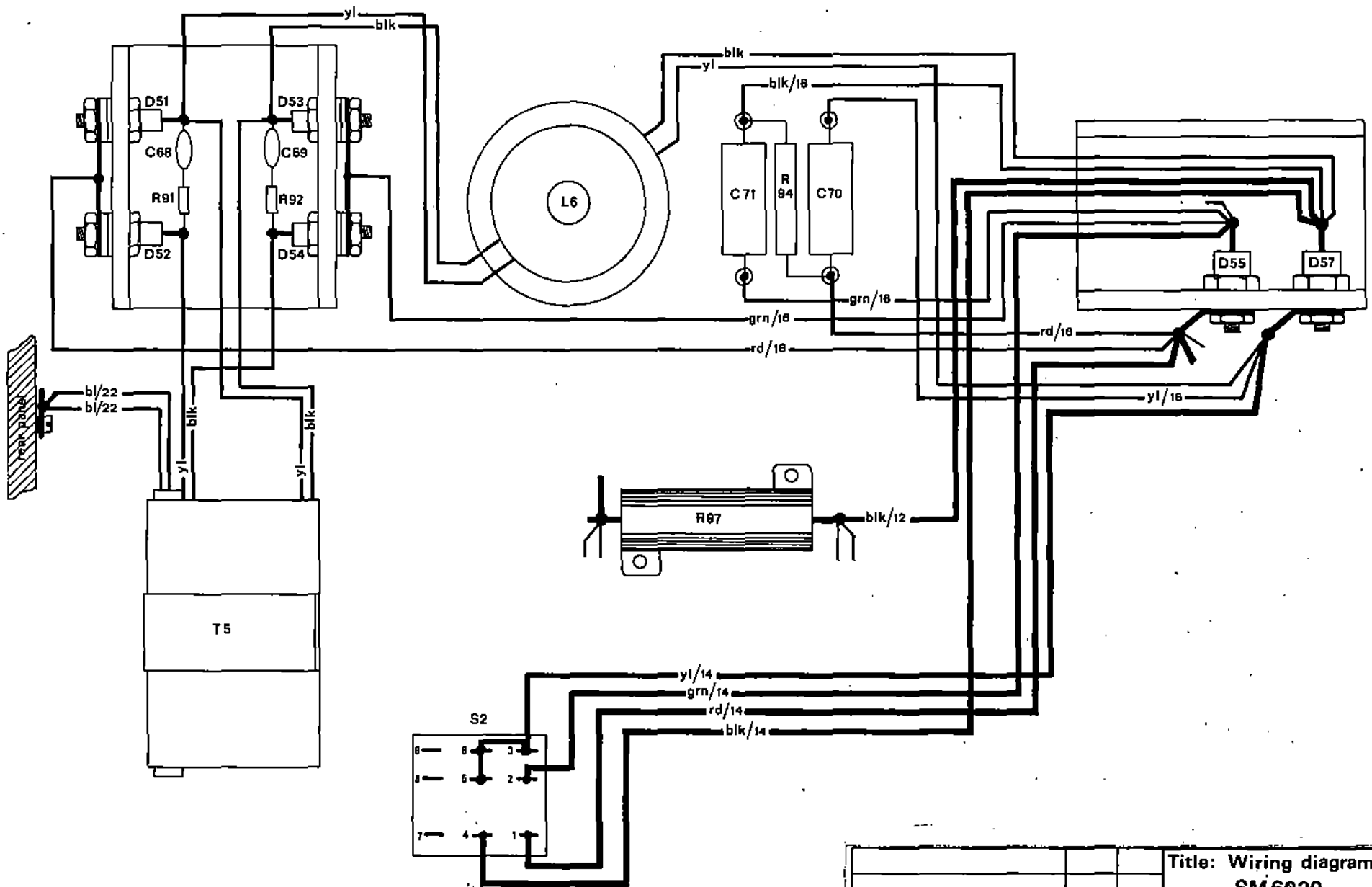

		Title: Wiring diagram	
		SM 6020	
		Date: 1-'79	
Modifications	Date	App	delta elektronika bv



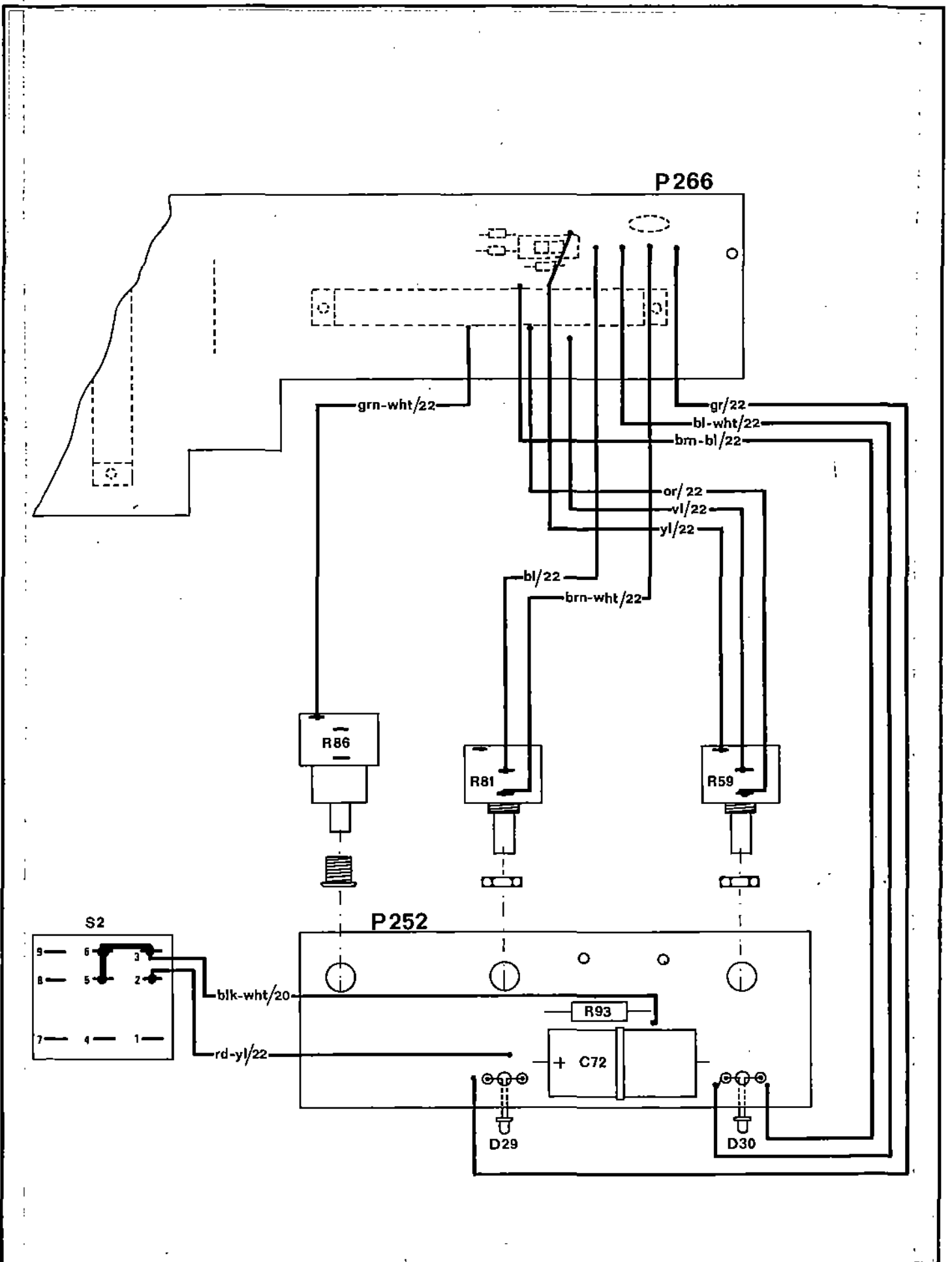

				Title: Wiring diagram SM 6020
Serial 0200 and up	11-'81	Vr	Date: 1-'79	delta elektronika bv
Modifications	Date	App		

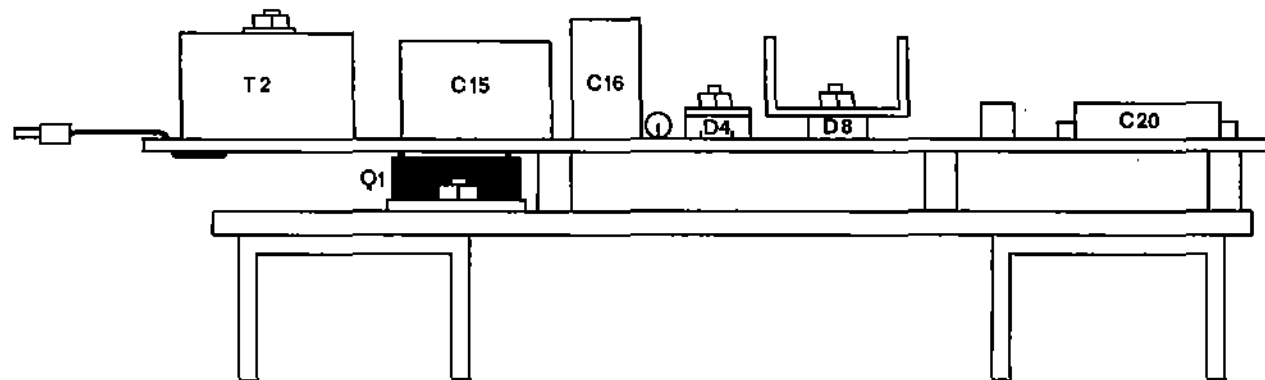
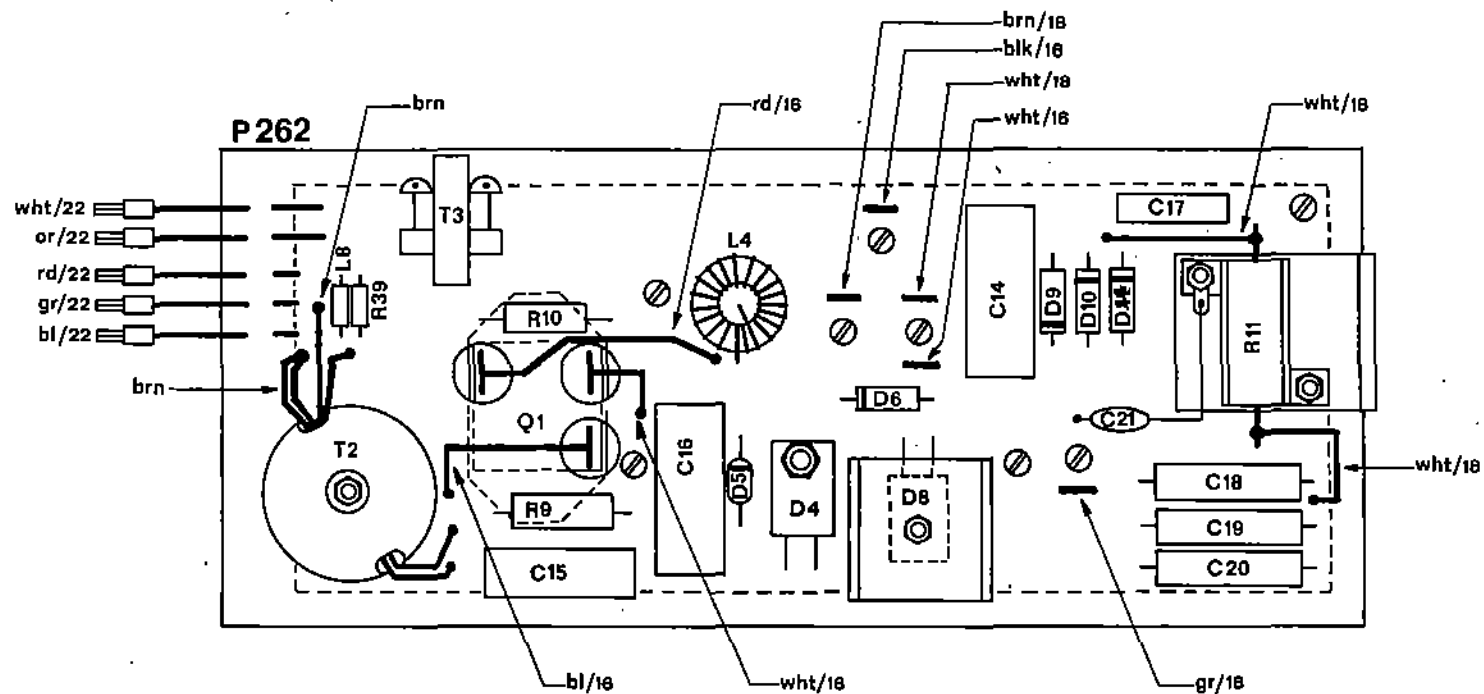

			Title: PC board SM6020
D3, 4, 5	12.84	Vr	Date: 1-'79
Serial 0200 and up	11.81	Vr	
Modifications	Date	App	delta elektronika bv



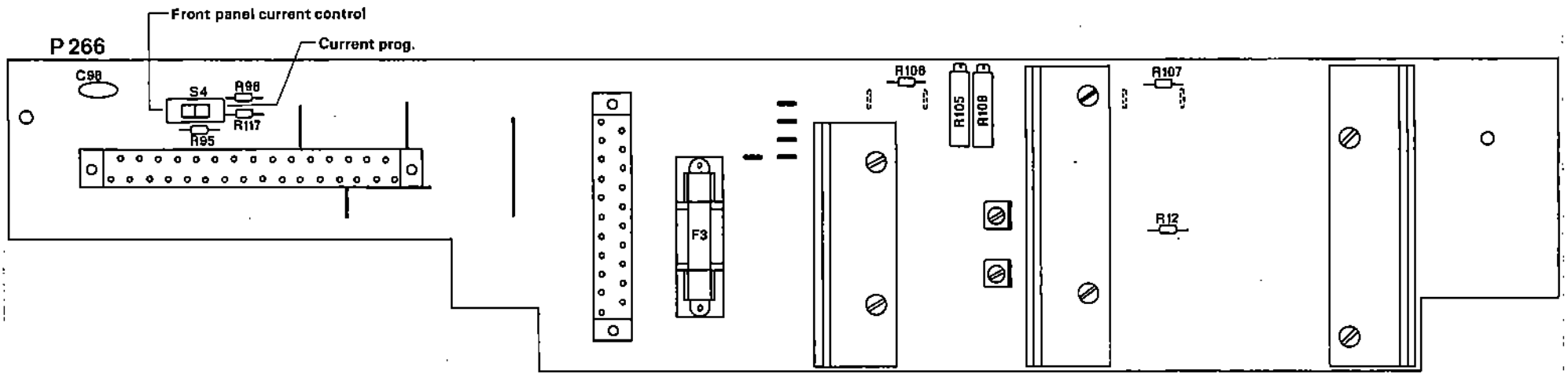

			Title: PC board
R117	6-'83	Vr	SM6020
Serial 0200 and up	11-'81	Vr	Date: 1-'79
Modifications	Date	App	delta elektronika bv



2/2

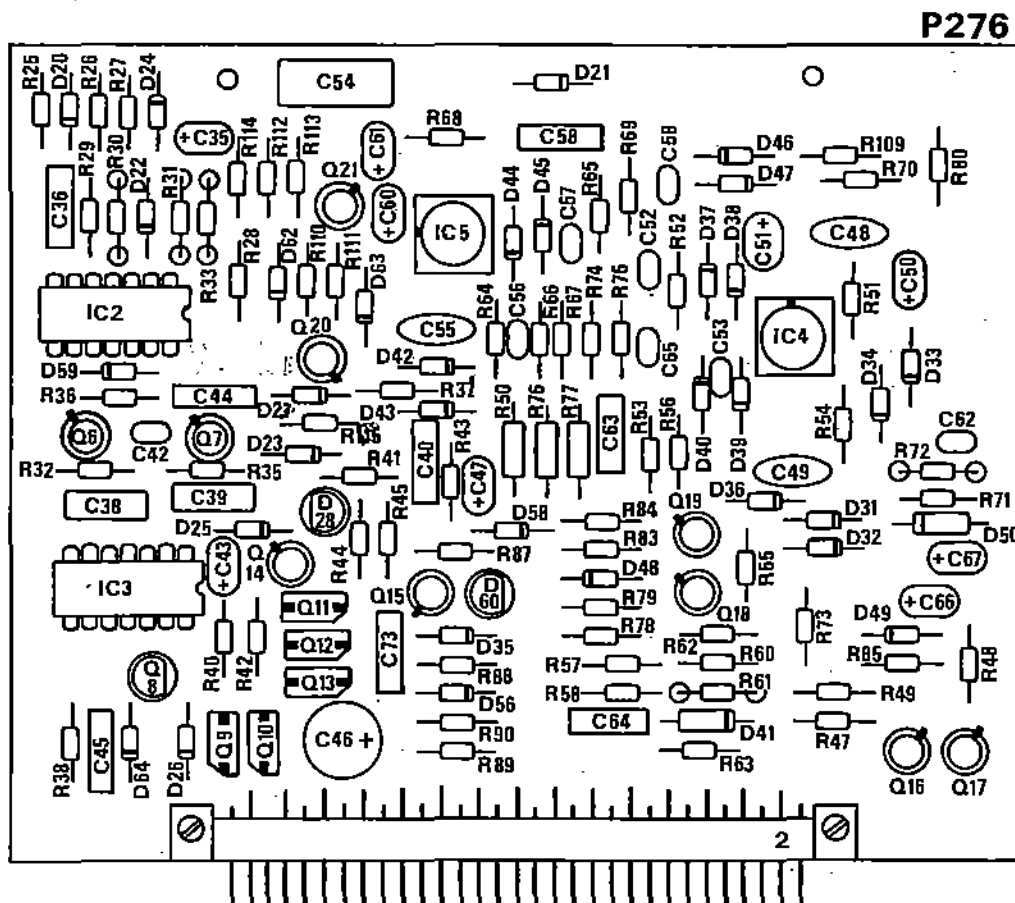
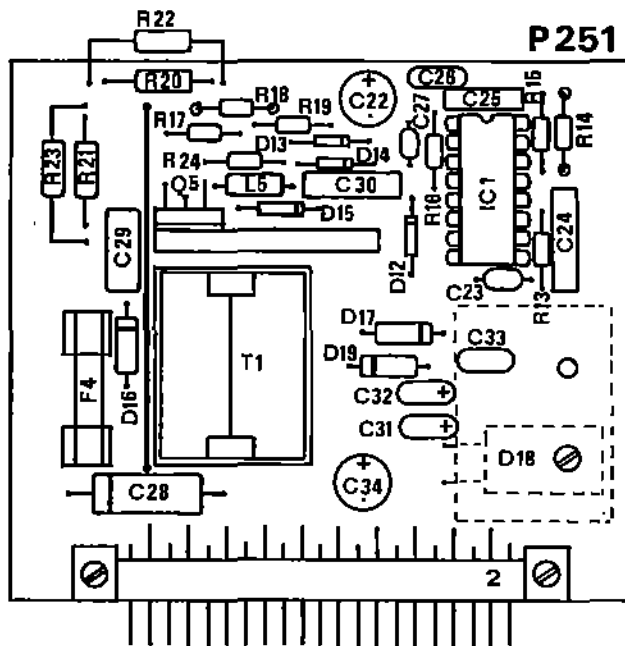

			Title: PC boards SM 6020
Serial 0200 and up	11.81	Vr.	Date: 1-'79
Modifications	Date	App.	delta elektronike bv



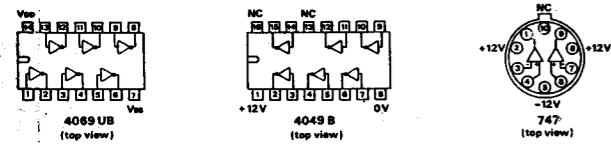
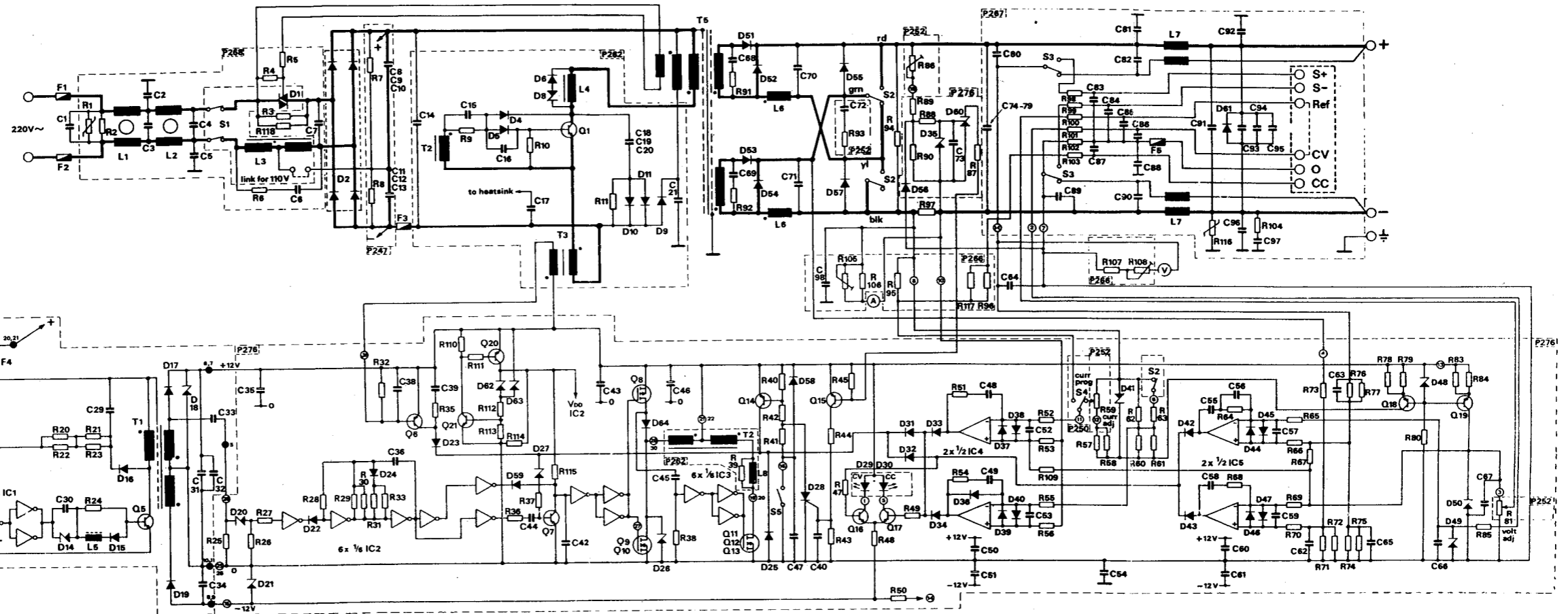

D3, R118	12-84	Vr	Title: Circuit diagram SM6020
R117	5-83	Vr	
Serial 0200 and up	11-81	Vr	Date: 1-'79
Modifications	Date	App	delta elektronika bv

